

## PB29 Series 2.5mm(.098") Flat Cable holder Connectors

- ⊙ With upper cover to prevent wire from pulling out
- ⊙ With PCB mounting peg
- ⊙ Insulator: Nylon 66 UL 94V-0, Color Natural
- ⊙ Tin plated contact with Pin kinked
- ⊙ Accommodates AWG #24 ~ #26 cables
- ⊙ Engineering No's: CI93 Series

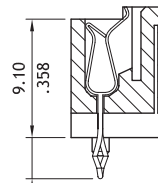
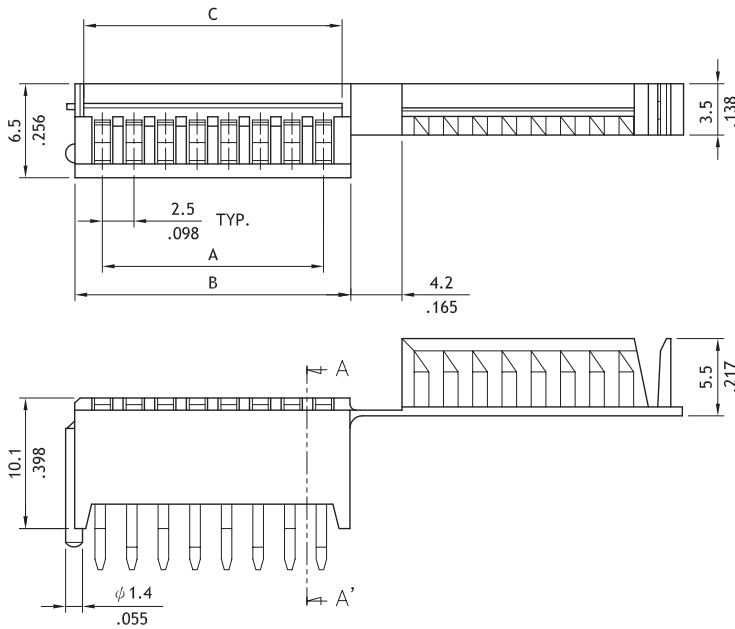

SEC.: A-A'

Circuits	Dimension		
	A	B	C
3	5.0(.197)	10.1(.398)	8.2(.324)
4	7.5(.295)	12.6(.496)	10.7(.421)
5	10.0(.394)	15.1(.594)	13.2(.520)
6	12.5(.492)	17.6(.693)	15.7(.618)
7	15.0(.591)	20.1(.791)	18.2(.716)
8	17.5(.689)	22.6(.890)	20.7(.815)
9	20.0(.787)	25.1(.988)	23.2(.913)
10	22.5(.886)	27.6(1.087)	25.7(1.012)

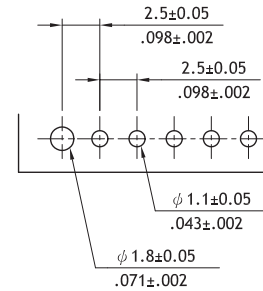

Recommended P.C. Board Layout

### Ordering Code

1
PB29
2
10
3
S
4
1
5
000

- ❶ Series No.
- ❷ No. of Circuits: 03 to 10
- ❸ S= Connector Housing
- ❹ Plating code:  
1= Tin over Nickel plated  
\* Optional plating available but MOQ requested

- ❺ Other options:  
000= Standard  
\* Special options Consult factory

# PB30 Series Serial ATA Signal Plug

- ⊙ DIP Straight signal plug for PCB mounted
- ⊙ SMT right angle signal plug with PCB mounting pegs
- ⊙ High temperature plastic for SMT process
- ⊙ For new serial ATA data communication
- ⊙ Engineering No's: CI94 Series



P/N	PB30P*V1000
-----	-------------

● Plug Connectors

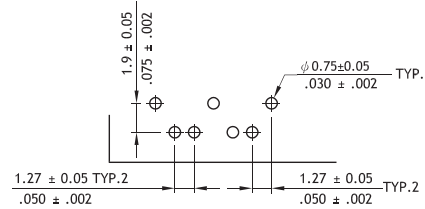
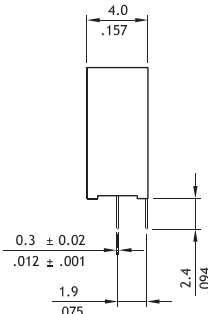
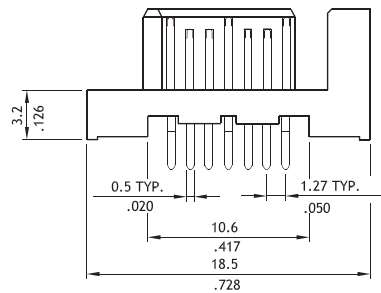
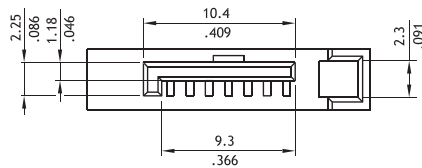

Recommended P.C Board Layout

P/N	PB30P*M1000
-----	-------------

● Plug Connectors

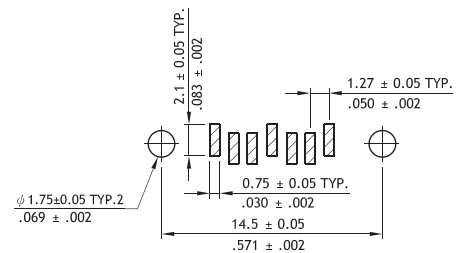
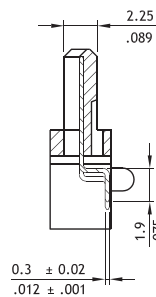
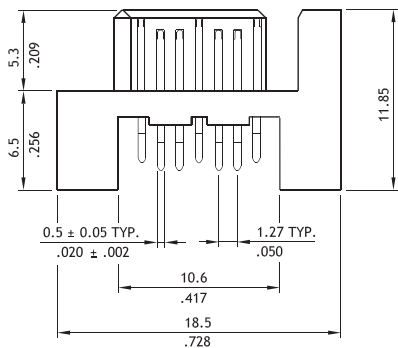
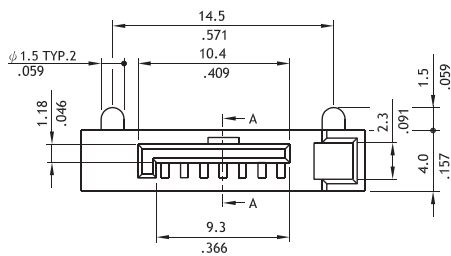

Recommended P.C Board Layout